



### Features and Benefits

- Robust sensor enclosure
- Easy installation with LED indication
- Supports 2-wire loop powering or 3-wire installation
- Built-in circuitry diagnostics

### Technical Overview

The RH-D range of humidity and temperature sensors offers the latest technology high precision and accuracy RH & T element.

Humidity accuracy is available as either high accuracy (2%) or standard (3%), there is also an optional direct resistive temperature output. Enthalpy and dewpoint measurement (RH-D-EN) is also available as well as an optional backlit LCD display.

A feature of this sensor is when in 3-wire mode it automatically detects the controller input type, 4-20mA or 0-10Vdc. This can be overridden via a DIP switch if required, also 2-wire loop powering (4-20mA) is also selectable via DIP switch.

Sensors have on-board LED indication for power up status, output mode type and useful self-test feature.

### Product Codes

<b>RH-D-AH</b>	Duct RH & T transmitter ±2%
<b>RH-D</b>	Duct RH & T transmitter ±3%
<b>RH-D-EN</b>	Duct Enthalpy & Dew point transmitter

Suffixes (replace -T with type)

**-T** Direct resistive temperature output

Thermistor types:

<b>A</b> (10K3A1)	<b>B</b> (10K4A1)	<b>C</b> (20K6A1)
<b>H</b> (SAT1)	<b>K</b> (STA1)	<b>L</b> (TAC1)
<b>M</b> (2.2K3A1)	<b>N</b> (3K3A1)	<b>P</b> (30K6A1)
<b>Q</b> (50K6A1)	<b>S</b> (SAT2)	<b>T</b> (SAT3)
<b>W</b> (SIE1)	<b>Y</b> (STA2)	<b>Z</b> (10K NTC)

Platinum types:

<b>D</b> (PT100a)	<b>E</b> (PT1000a)
-------------------	--------------------

Nickel types:

<b>F</b> (NI1000a)	<b>G</b> (NI1000a/TCR (LAN1))
--------------------	-------------------------------

<b>-LCD</b>	Integral LCD
<b>-TR</b>	Custom temperature output range scaling
<b>-5V</b>	Output 0-5Vdc (instead of 0-10Vdc)

Accessory

<b>DPA</b>	Duct probe adjustment flange
------------	------------------------------

### Specification

Outputs:	3-wire	0-10Vdc (0-5V for -5V) or 4-20mA
	2-wire	4-20mA, loop powering
	(optional -T)	PTC/NTC resistive sensing element
Power Supply:		24Vac/dc ±10% (3-wire)
		24Vdc ±10% (2-wire)
Supply current:		30mA (3-wire) max.
Electrical connections		Pluggable spring loaded terminal block min. 0.2mm <sup>2</sup> , max. 1.5mm <sup>2</sup>
Output ranges;	RH	0 to 100%
	Temperature	-20 to 50°C
	Enthalpy	-20 to +250 kJ/kg (-EN only)
	Dew point	-50 to +50°C (-EN only)
Environmental:	Housing:	-30 to 60°C
		0 to 95% non-condensing
	Media:	-10 to +50°C
Housing:	Material	PC/GF (Halogen free, flame retardant & UV stabilized)
	Dimensions	123 x 103 x 54mm
Probe:	Material	Probe PVC - End cap Delrin
	Dimensions	200 x 20mm dia.
Protection		IP65
Country of origin		UK
Conformity		EMC, CE & UKCA Marked

#### WEEE Directive:



At the end of the products useful life please dispose as per the local regulations. Do not dispose of with normal household waste. Do not burn.



## Sensor Characteristics

### Humidity

Measurement range	0 to 100% RH	
Type	ASIC	
Accuracy (20 to 80% RH):	Typical	Maximum
RH-D-AH	±2% RH	±3% RH
RH-D	±3% RH	±4% RH
Long term stability	<0.5% RH p.a.	
Response time	8 seconds (t 63%) @ 25°C 1 m/s Airflow	

### Temperature

Measurement range	-20 to 50°C
Accuracy (20 to 40°C)	±0.5°C
Long term stability	<0.02°C p.a.

### Enthalpy

Measurement range	-20 to +250 kJ/kg
Accuracy	1.8 kJ/kg typical (27 kJ/kg max)

### Dew point

Measurement range	-50 to +50°C
Accuracy	1.2°C typical (4°C max)

### Optional Passive Output

Type	Resistive PTC & NTC types
Accuracy:	
Thermistor	±0.2°C 0 to 70°C
Platinum types	±0.2°C @ 25°C
Nickel types	±0.4°C @ 25°C

### Display Option

LCD	To show T and RH values
	To show RH only (-T version)
	To show T, RH, DP and EH (-EN version)

## Installation



Antistatic precautions must be observed when handling these sensors. The PCB contains circuitry that can be damaged by static discharge.

**Note: Sontays range of RH sensors are not suitable for use in swimming pool & spa applications. Sensors used in these types of applications are not covered under Sontays warranty terms. Chemicals used in swimming pool & spas can contaminate the humidity element, which results in a reduced service life.**

1. Select a location in the duct where dust & contaminants are at a minimum (i.e. after filters etc.) and which will give a representative sample of the prevailing air condition.
2. Fix the housing to the duct with appropriate screws, or by using the optional duct mounting flange.
3. Release the snap-fit lid by gently squeezing the locking tab and feed the cable through the waterproof gland and terminate the cores at the terminal block. Leaving some slack inside the unit, tighten the cable gland onto the cable to ensure water tightness.
4. If the sensor is to be mounted outside, it is recommended that the unit be mounted with the cable entry at the bottom. If the cable is fed from above then into the cable gland at the bottom, it is recommended that a rain loop be placed in the cable before entry into the sensor.
5. Set the switch on the PCB either to the 3-wire or 2-wire position. Please refer to "Selecting output mode and LED indication" for more details. Snap shut the lid after the connections have been made.

**IMPORTANT** Do not alter the switch position while sensor is powered up. Do not select 2-wire if a 0v connection (3-wire) is made. Permanent damage to the sensor or BMS controller may result.

**IMPORTANT** Ensure the Terminal Block is fitted the correct position and direction. The cable entry faces the centre of the sensor.

6. Connect all sensor outputs to the controller inputs or to the device, the sensor output(s) are connected to.
7. Before powering the sensor, ensure that the supply voltage is within the specified tolerances.

**IMPORTANT** Make all electrical output connections before applying the supply voltage. If the sensor is not connected in this sequence, damage may be caused to the input circuitry of the controller or device the sensor output(s) are connected to.

8. Allow 3 minutes before checking functionality, and at least 30 minutes before carrying out pre-commissioning checks. This will allow the electronics time to stabilise.

To perform an accurate comparison between a transmitter output and a portable reference, it is essential that the two probes are held adjacent for a minimum of 30 minutes in a stable RH environment. Only in this way can speed of response and temperature factors be eliminated. It is not uncommon for test instruments and transmitters to disagree by 10% RH or more when site measurements are taken incorrectly. 'Slings' or other mechanical hygrometer should not be used as a reference

### Terminal Block:

For easier installation, the terminal block can be detached from the PCB.

When used with ferrules it doesn't require any tools to release the spring loaded terminal block. When used with stranded cable, push in the orange latch to compress the spring load. Feed in the wire and release the spring to secure the wire connection.

**IMPORTANT** Make sure the Terminal Block is fitted the correct position and direction. The cable entry faces the centre of the sensor.

### Electrical Connections:

<b>24V</b>	Supply 24Vac/dc	
<b>0V</b>	Supply 0V (Common 0V)	
<b>OP1</b>	RH output	(Enthalpy for -EN option)
<b>OP2</b>	Temperature output	(Dew point for -EN option)
<b>OP3</b>	Not used	
<b>0V</b>	Not used	
<b>TH1</b>	Direct Thermistor output	(-T only)
<b>TH2</b>	Direct Thermistor output	(-T only)

### LED Indication:

<b>LOOP</b>	Blue
<b>4-20mA</b>	Yellow
<b>0-10V</b>	Green
<b>ERROR</b>	Red

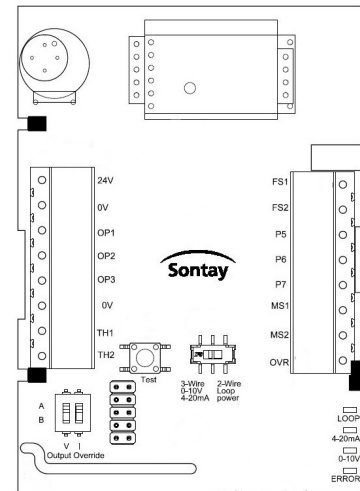

3-wire, 0-10Vdc / (0-5Vdc optional):

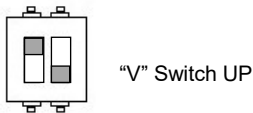
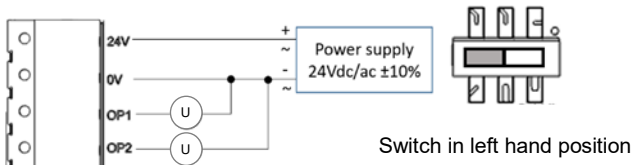

3-wire, 4-20mA:

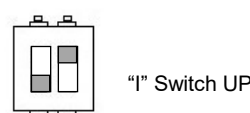
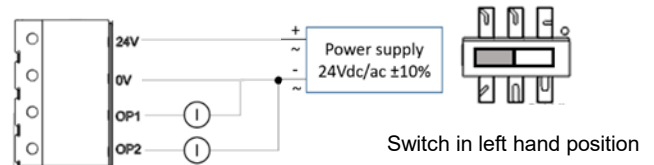

2-wire, 4-20mA:

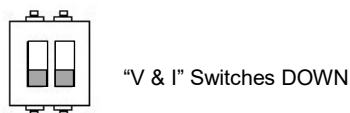
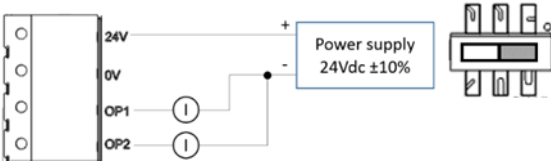

-T, direct resistive output:



See next page for further information on setting output modes.

### Selecting output mode and LED indication:

**IMPORTANT** Do not alter the switch position while sensor is powered up. Do not select 2-wire if a 0v connection (3-wire) is made. Permanent damage to the sensor or BMS controller may result.

#### 3-wire connection:

Ensure there is no power to the sensor before changing the switch. Set the switch in the left hand position. The sensor automatically sets the outputs to 0-10V or 4-20mA based on the resistive load on the outputs. All outputs MUST be connected to the same type of load:

- If ALL the loads are  $>2k\Omega$ , all the outputs will be set to 0-10Vdc and the green 0-10V LED will light.
- If ALL the loads are  $>50\Omega$  and  $<550\Omega$ , all the outputs will be set to 4-20mA and the yellow 4-20mA LED will light.
- If ANY of the loads are  $<50\Omega$  or  $>550$  and  $< 2k\Omega$ , all the outputs will be switched off and the red ERROR LED will light.

Auto detection can be overridden via 2-way DP switch situated on the left hand side of the PCB.

Set the auto detection 2-way DIP switch to the **3-wire** position

Set the override 2-way switch to:

- Voltage (0-10V/0-5V) switch DIP1 (V) to ON
- Current (4-20mA) switch DIP2 (I) to ON

The ON position for the switch is labelled on the switch itself.

Example, if you set the V switch (left) to OFF and the I switch (right) to ON, the device will force 3-wire current mode. The device is also set up to detect a change on these switches and reboot itself after 5 seconds - the error LED will flash during this period then the yellow 4-20mA LED will illuminate.

#### 2-wire connection:

Ensure there is no power to the sensor before changing the switch and do not connect 0V. Set the switch in the right hand position. All outputs MUST be connected. The blue LOOP LED will light.

The LEDs will switch off after 15 minutes.

### Self-Test Button:

The self-test button helps the installer to validate the wiring for each output and helps to commission the system.

When self-test button is pushed it cycles all outputs as follows: 0%, 50%, 100%, normal operation. After 30 seconds in any mode the system resets to normal operation.

When self-test button is held for more than 3 seconds, it sets all outputs to 50%, when released the outputs return to normal operation.

**Dimensions:**

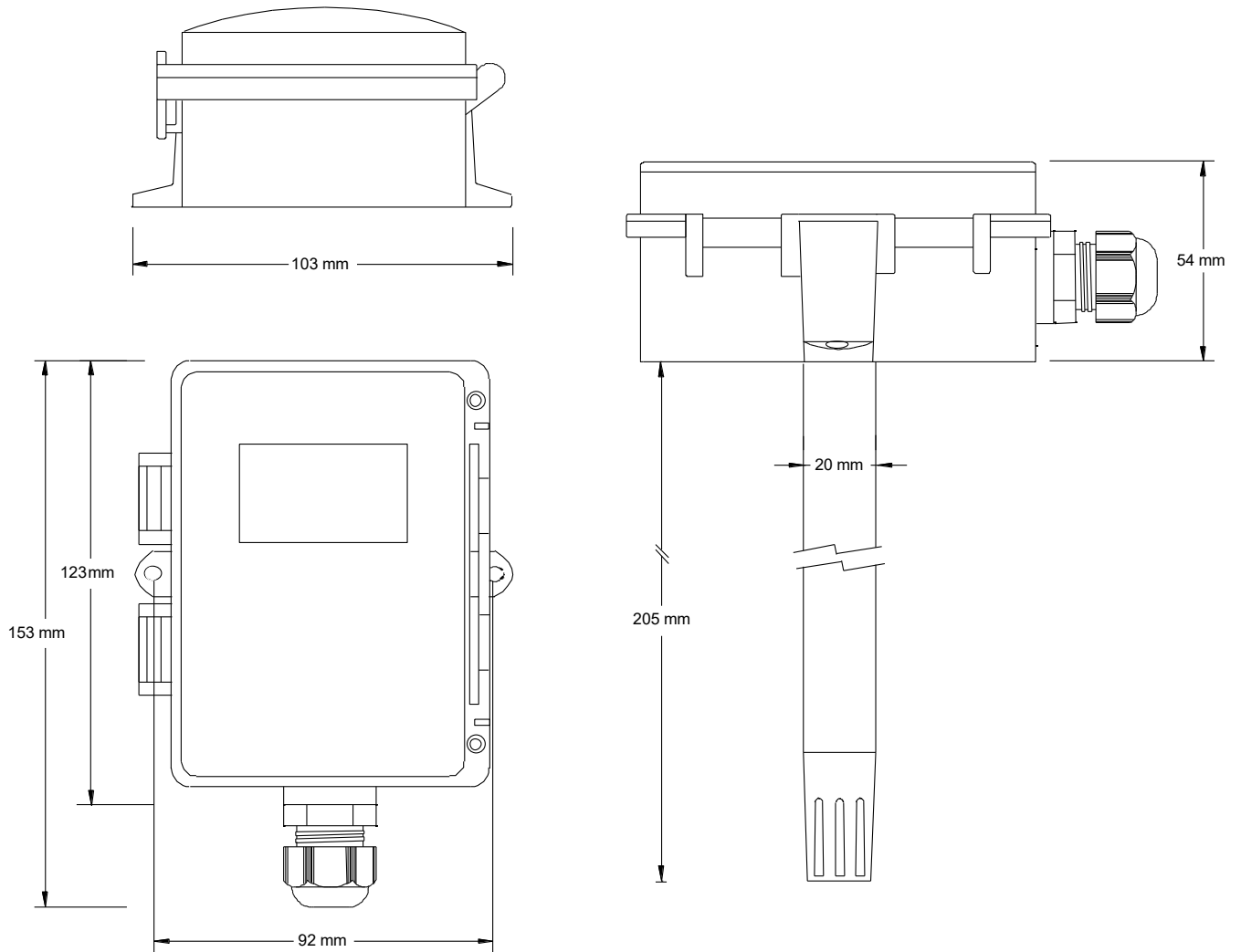

**Revision History:**

Rev.	Description of change	Page No.	Date
7.3	Output type override & dimensions	3, 4 & 5	05/05/2022
7.2	UKCA added	1	30/09/2021
7.1	Change over of outputs, OP1 & OP2	3	31/01/2020
7.0	New product	All	24/09/2019

Whilst every effort has been made to ensure the accuracy of this specification, Sontay cannot accept responsibility for damage, injury, loss or expense resulting from errors or omissions. In the interest of technical improvement, this specification may be altered without notice.